

IP66 OUTDOOR

Technical data pages by Formrack

Outdoor 19" Field Type Cabinet
Cabinet Reference Rack: 12U 600x600

FORMRACK®

General Features

- Openable and lockable front cover.
- Full protection against dust and water ingress with IP66 structure.
- Openable top structure that provides external access to the fan module.
- Standart 100 mm plinth.
- Cable entry slots are located at the bottom part.
- Air inlet louvers with dust filter.
- Air vent part with dust filtered fan.
- Ventilation can be provided by cooling units with 1 or 2 fans.
- 12U height option.
- Mounting profiles have U markings that facilitate the mounting process.
- It can be mounted to the ground.
- Higly effective zirconium + zinc coating against corrosion.
- Painted by impact-resistant, high strength, electrostatic Ral 7035 gray.
- All test procedures have been carried out and has RoHS, CE, EN 61587-1 standards.



Technical Descriptions

Dimensions W*D	: W:600 mm D:600 mm
Available U - Sizes	: 12U
Paint Type	: Electrostatic powder paint
Standarts	: In accordance with the standard TS EN IEC 61587-1: 2022 / ISO9001-2015 / ISO14001-2015 / ISO 45001-2018 / ISO 27001:2017 / RoHS / UL 2416
Material	: Sheet Steel, DIN EN 1030-99 / DC-01 6112 / DC-7122
Load Carrying Capacity	: 600kg / 1 322.77lbs
IP rating	: IP66
Available Colors	: Ral 7035 Light Gray

FORMRACK

Address: Akcaburgaz Mah. 592. Sokak No:10 B Blok 34522 Esenyurt - Istanbul - Türkiye
T: +90 212 565 56 50 / F: +90 212 567 40 46 www.formrack.com / sales@formrack.com

IP66 OUTDOOR

IP66 OUTDOOR

Technical data pages by Formrack

Outdoor 19" Field Type Cabinet
Cabinet Reference Rack: 12U 600x600

FORMRACK

Exploded View

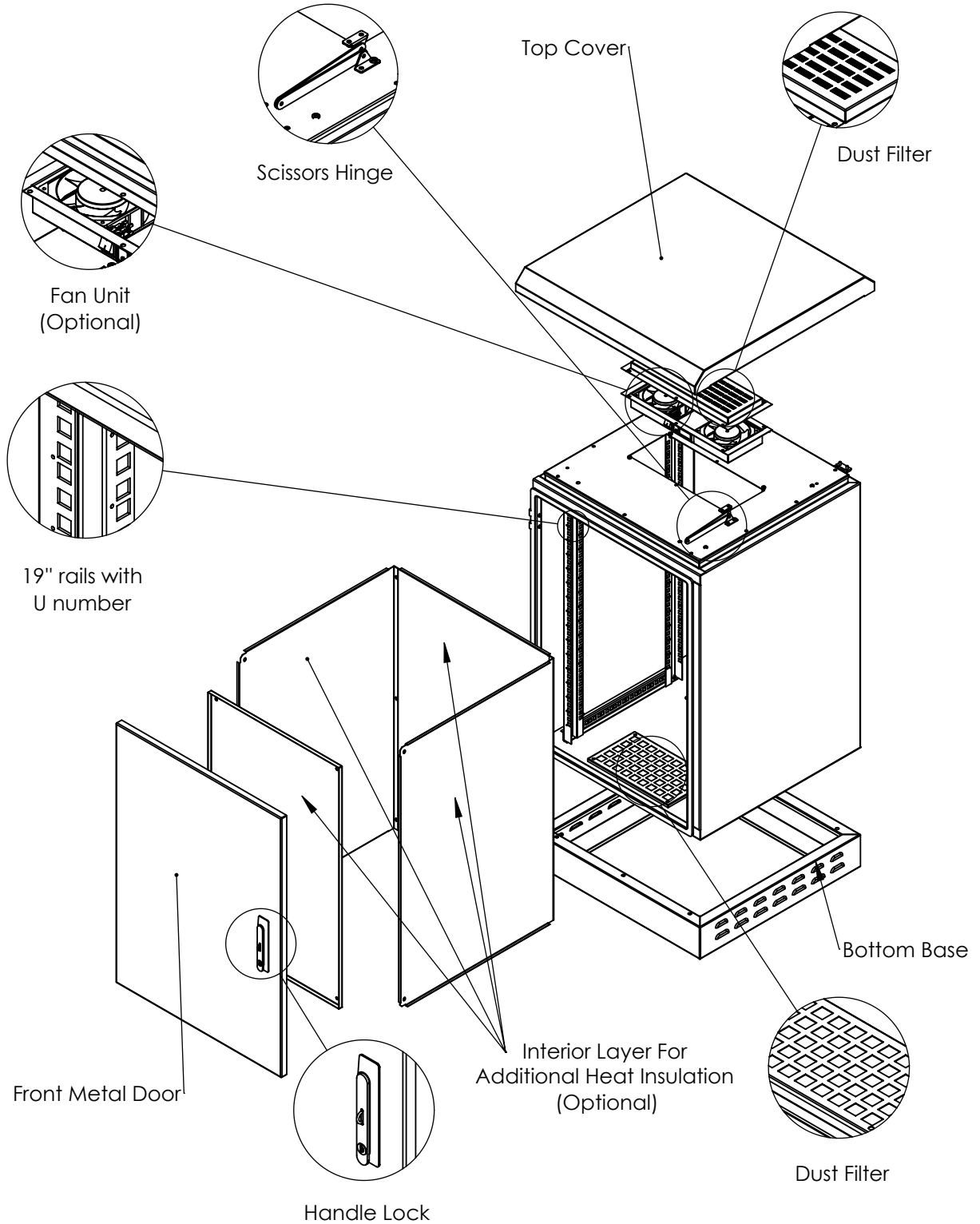

IP66 OUTDOOR

FORMRACK

Address: Akcaburgaz Mah. 592. Sokak No:10 B Blok 34522 Esenyurt - Istanbul - Türkiye
T: +90 212 565 56 50 / F: +90 212 567 40 46 www.formrack.com / sales@formrack.com

IP66 OUTDOOR

Technical data pages by Formrack

Outdoor 19" Field Type Cabinet
Cabinet Reference Rack: 12U 600x600

FORMRACK®

Front View

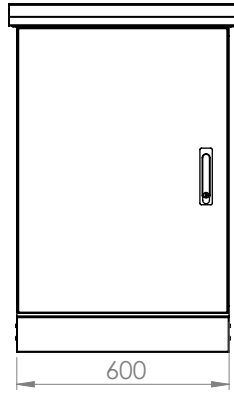

Side View

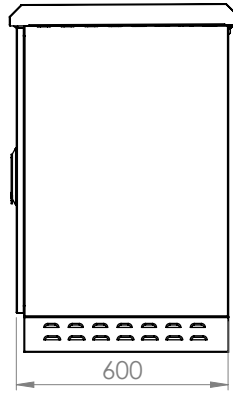

Front Detail View

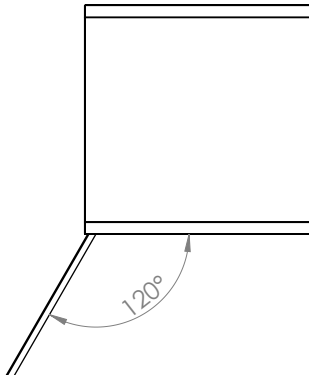
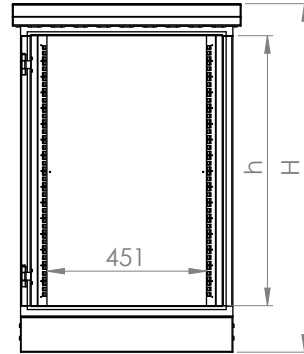

Top View

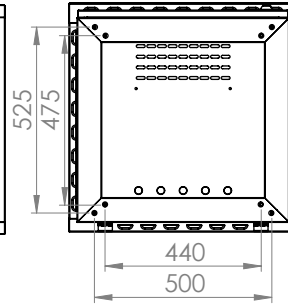

Bottom View

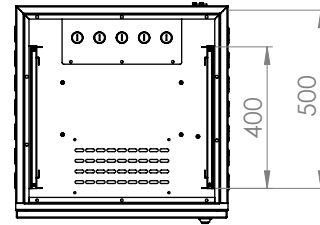

Top Detail View

SINGLE LAYER

Product Number	Product Name	Dimensions (WxDxH) (mm)	U	H (mm)	h (mm)	Weight (kg)
FORM OUT-12U600Z	12U 600 IP66 OUTDOOR FIELD TYPE CABINET	600x600x808	12	808	583	39

DOUBLE LAYER

Product Number	Product Name	Dimensions (WxDxH) (mm)	U	H (mm)	h (mm)	Weight (kg)
FORM OUT-12U600ZW	12U 600 IP66 OUTDOOR FIELD TYPE CABINET	600x600x808	12	808	583	48

IP66 OUTDOOR

FORMRACK

Address: Akcaburgaz Mah. 592. Sokak No:10 B Blok 34522 Esenyurt - Istanbul - Türkiye
T: +90 212 565 56 50 / F: +90 212 567 40 46 www.formrack.com / sales@formrack.com